

**MOULD
KING**

®

Model S
宇星车模

"迷你"名车

NO.488 GTB

宇 | 星 | 模 | 王

NO.27006

329+ Pcs/Pza



Customer Service
客户服务



www.yx-mk.com

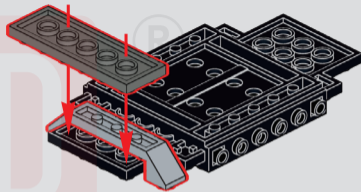
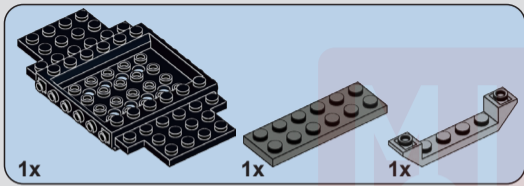

1

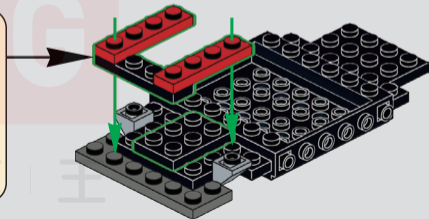
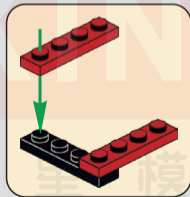
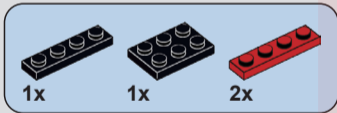

2

(Technic Pin without Friction)
(光滑栓)

2x 2x 2x 1x

3

2x

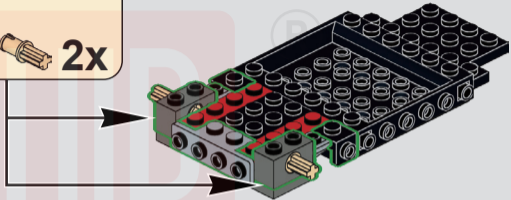

1x 1x 4x 2x

4

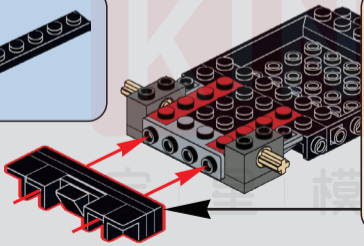

1 2 3

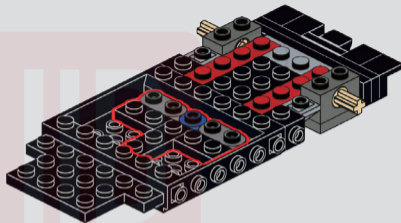

5

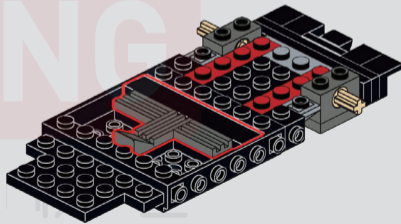
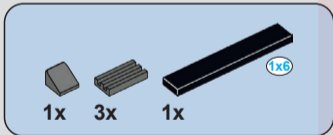

6

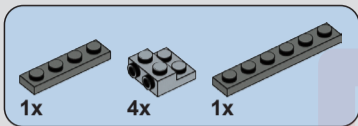

7

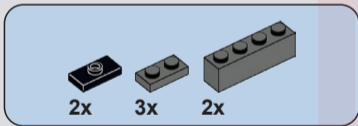
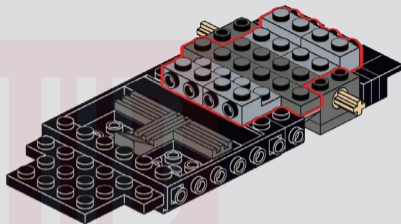

8

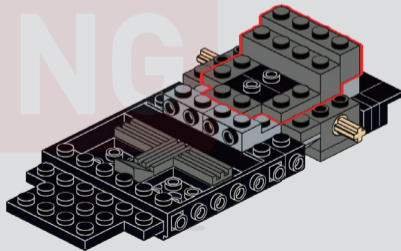

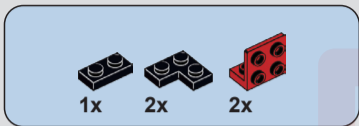

9

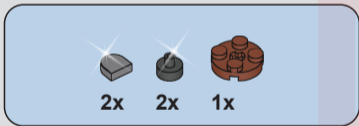
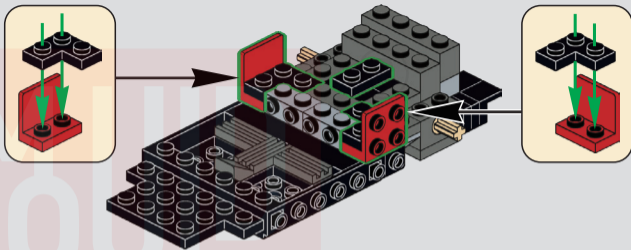

10

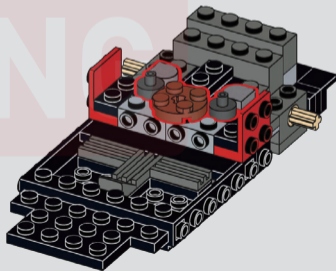

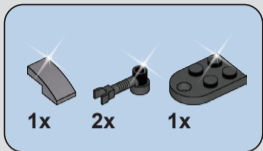

11

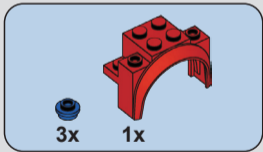
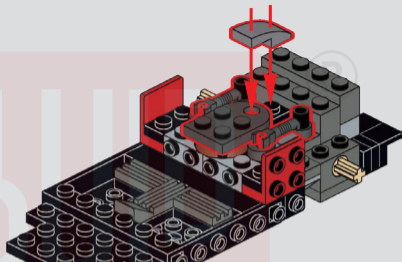

12

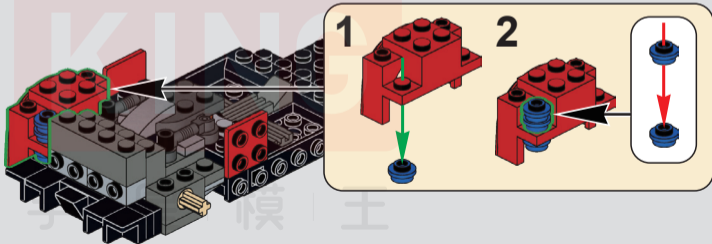

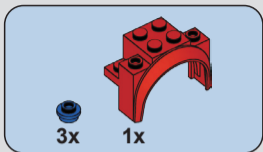

13

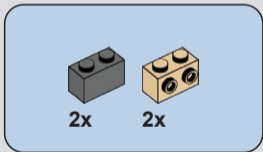
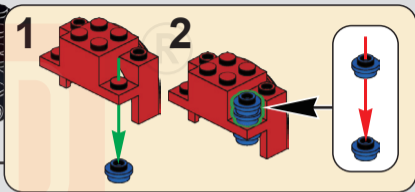
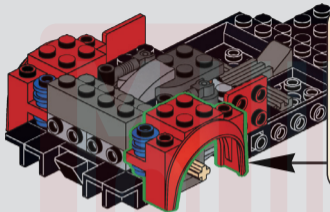

14

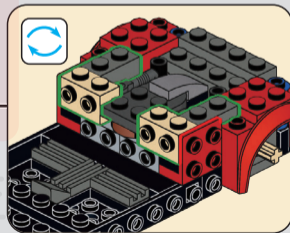
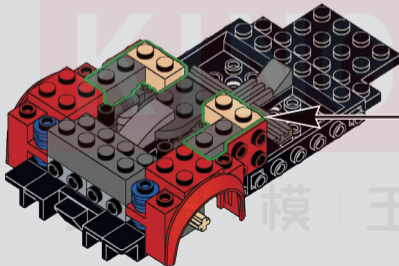



15

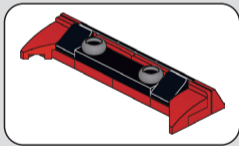
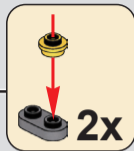
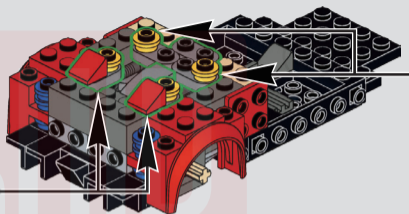

16

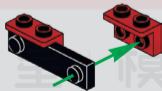

17

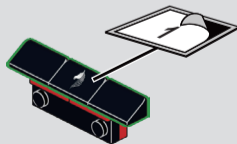

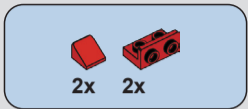

18

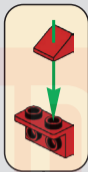
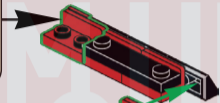
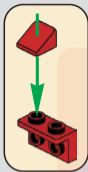

19

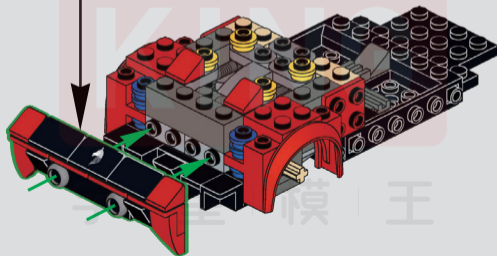
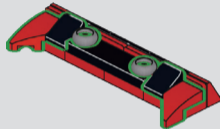

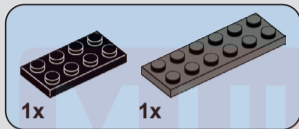
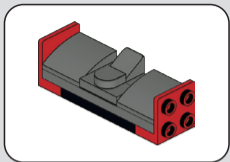

20

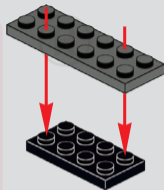

21

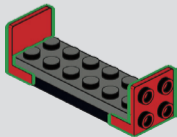

22

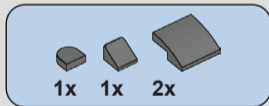
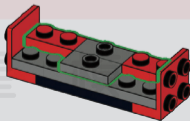

23

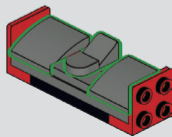

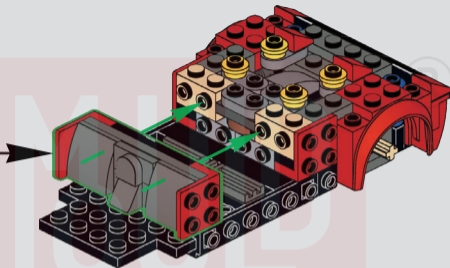

24

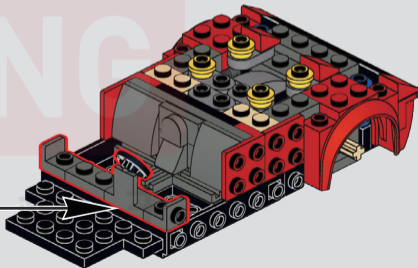

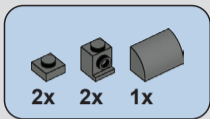

25

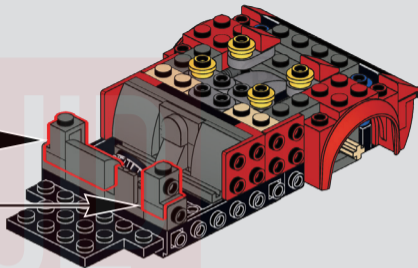
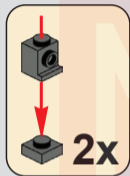

26

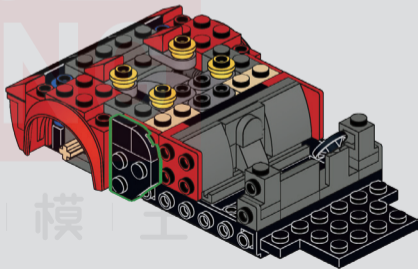

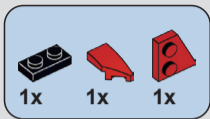

27

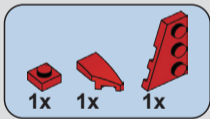
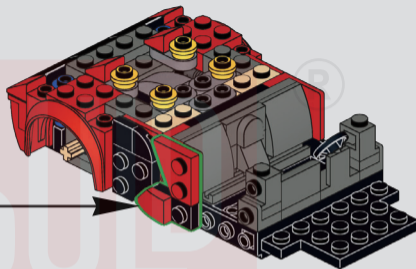
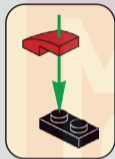

28

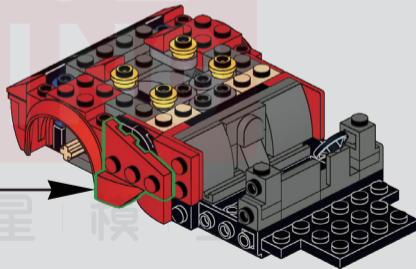
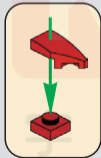

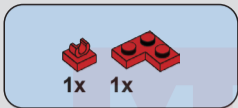
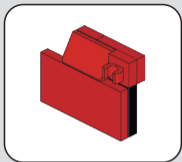

29

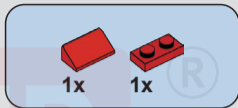
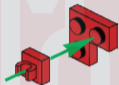

30

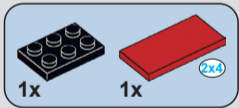
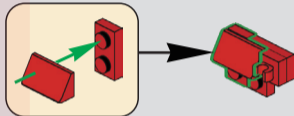

31

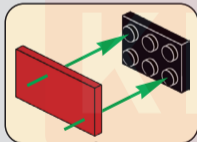
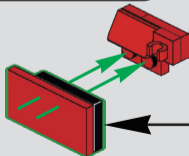

32

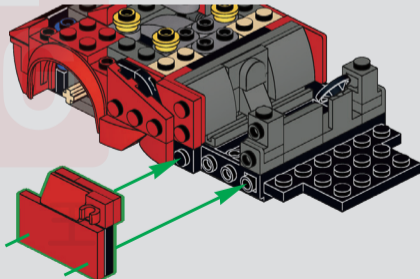

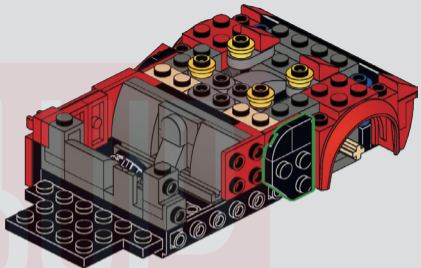
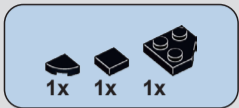

33

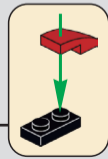
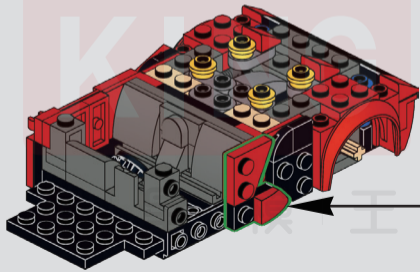

34

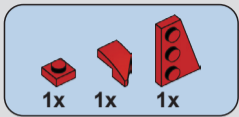

35

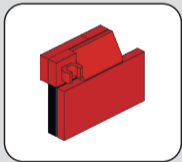
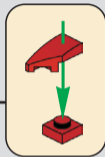
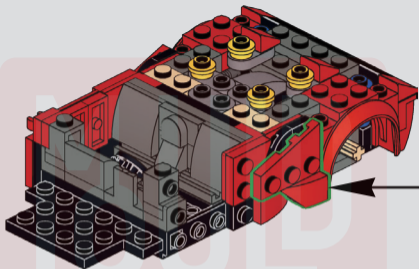

36

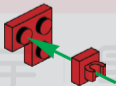

37

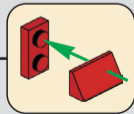

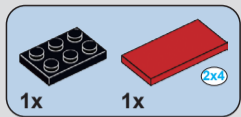

38

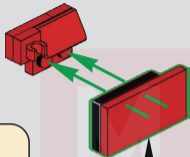
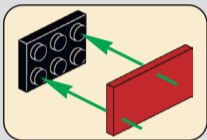

39

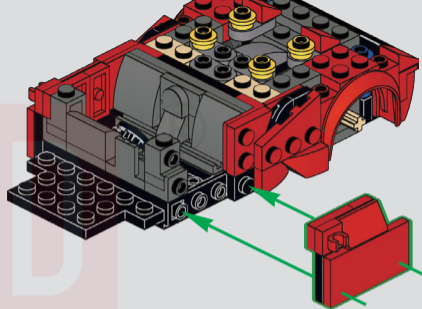

40

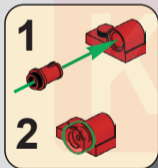

2

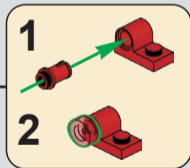

2



宇

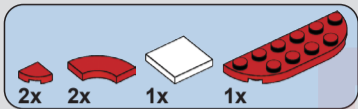

41

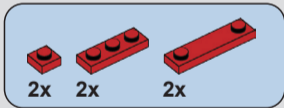
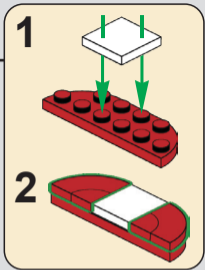
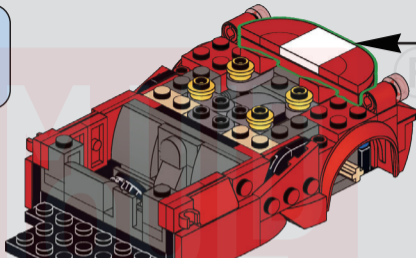

42

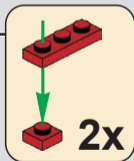
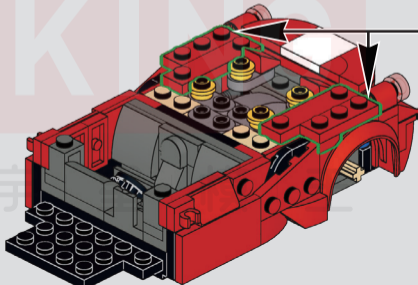

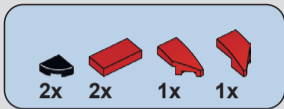

43

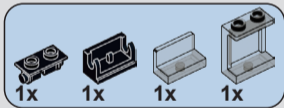
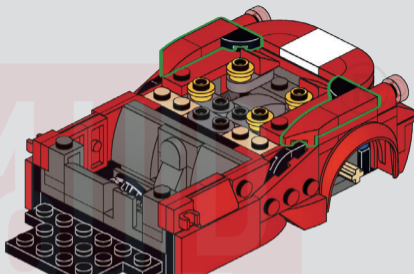

44

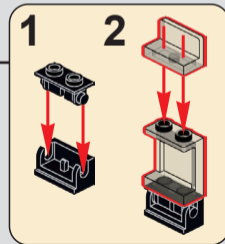
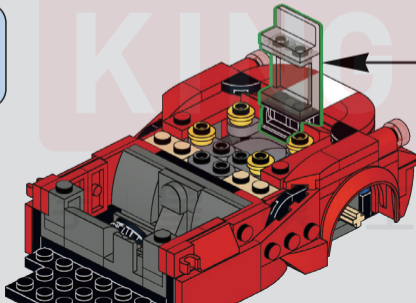

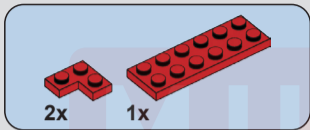
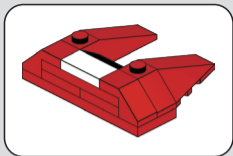

45

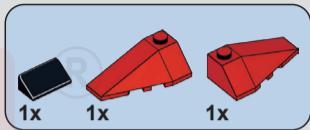
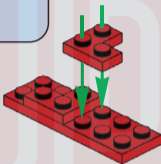

46

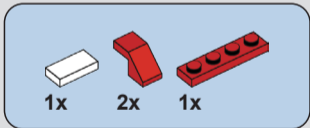
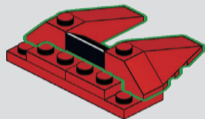

47

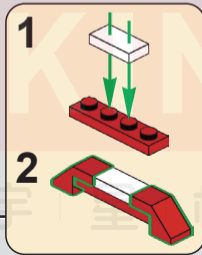
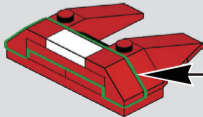

48

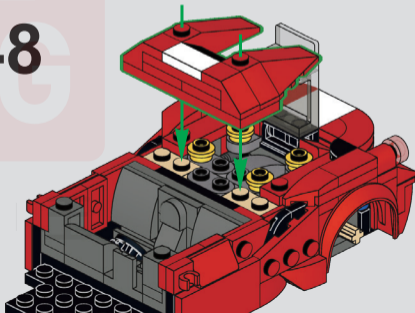

* (Plating) (电镀配件)

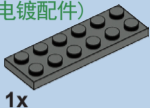

49

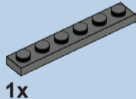
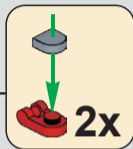
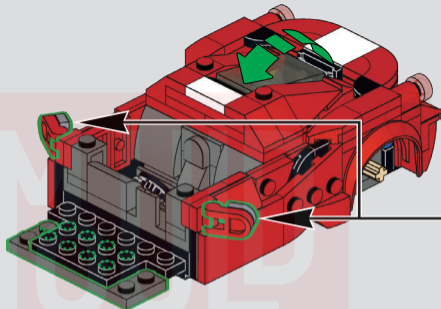

50

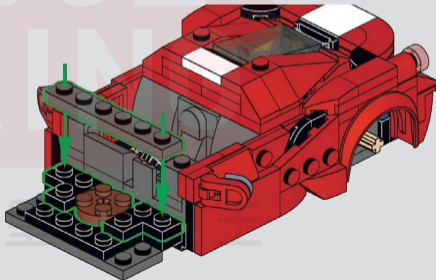

(Technic Pin without Friction)

(光滑栓)



2x



2x



1x

51

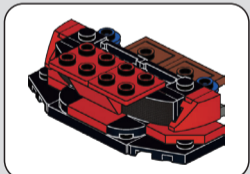
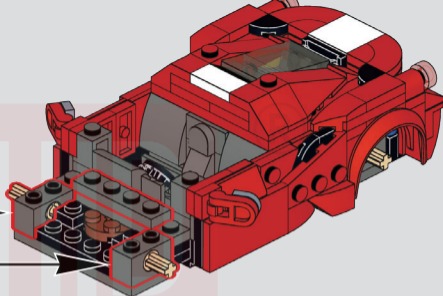
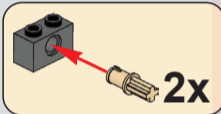

1x

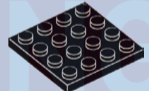

1x

52

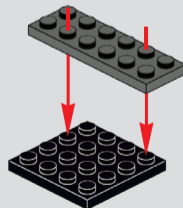



53

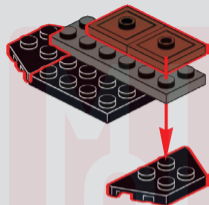

54

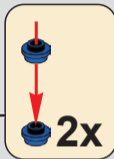
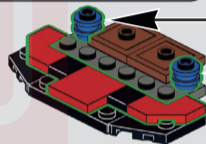

55

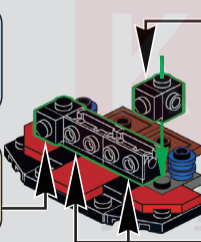
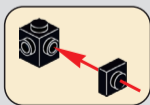

56

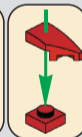
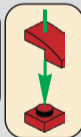
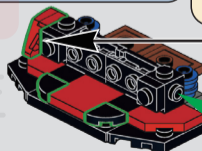

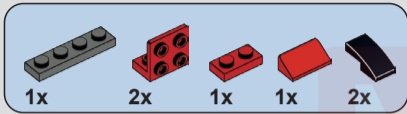

57

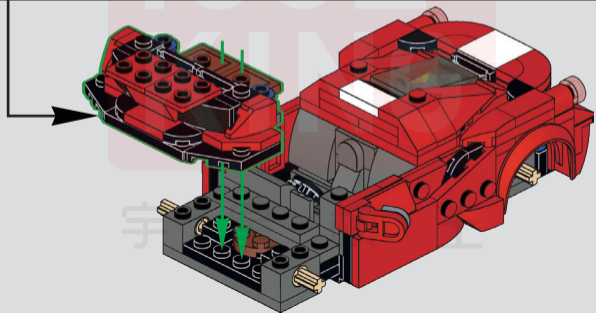
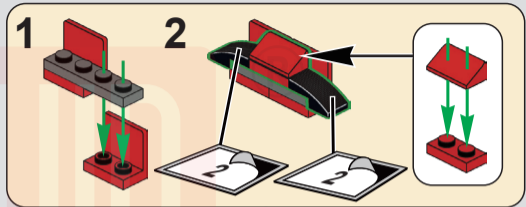
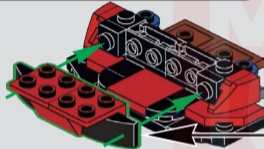

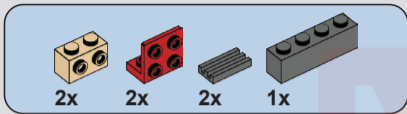

58

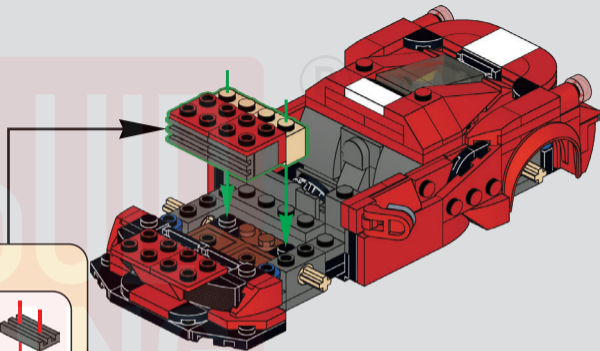
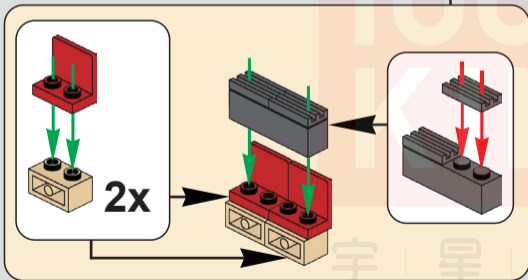

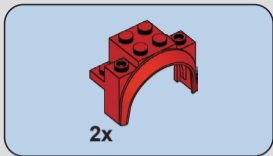

59

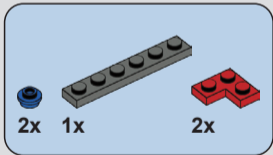
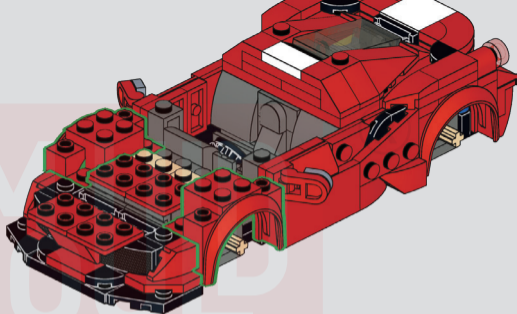

60

26

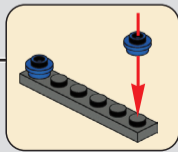
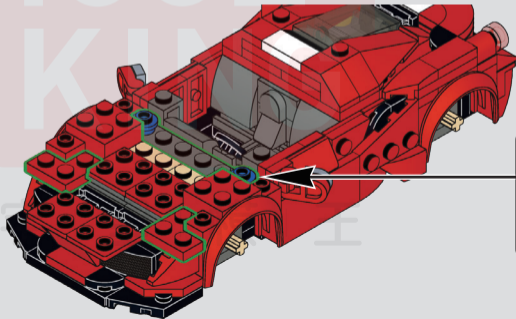

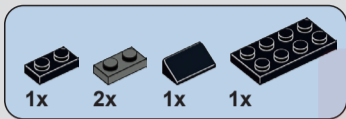

61

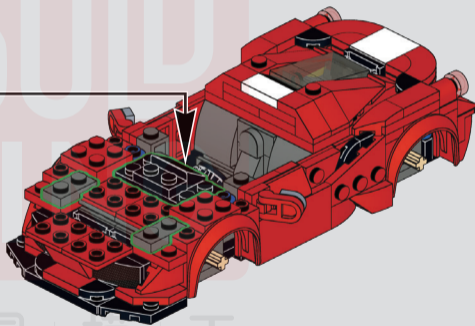
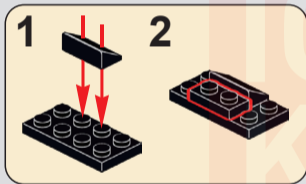

宇 | 星 | 模 | 王

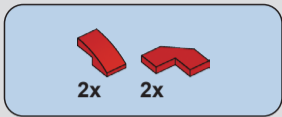

62

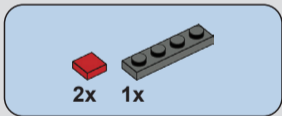
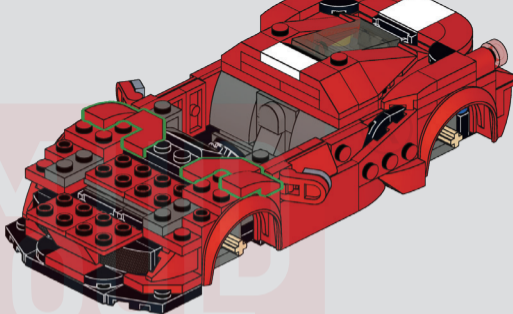

63

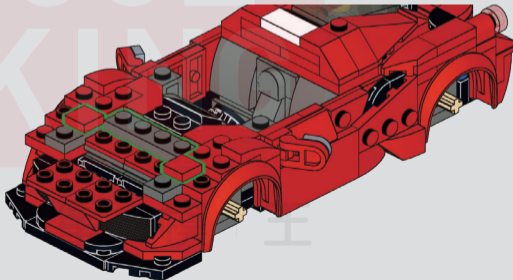

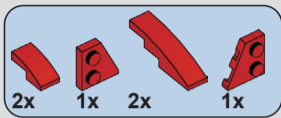

64

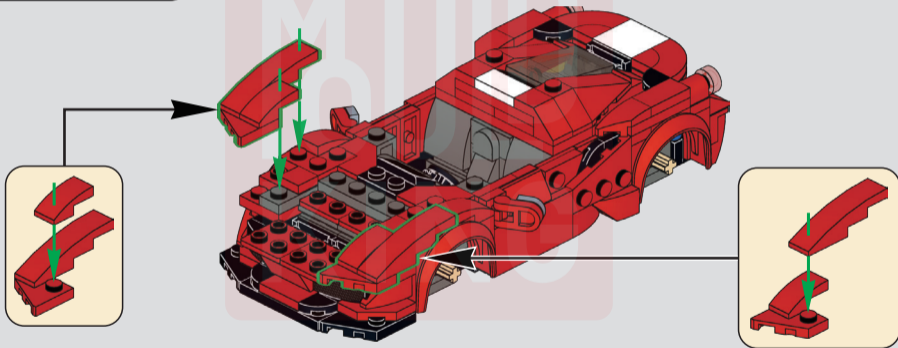

宇 | 星 | 模 | 王

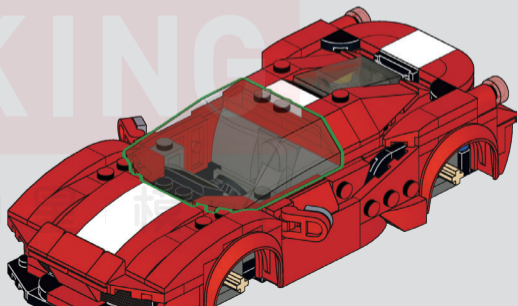
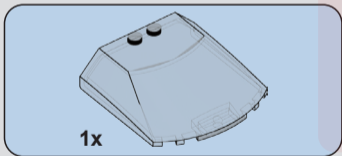
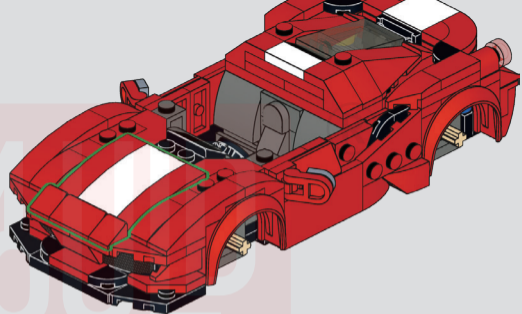
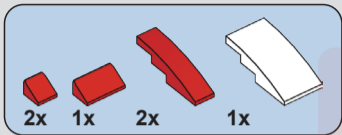

66

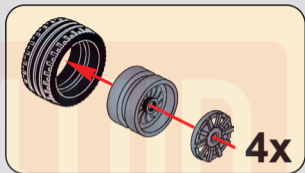

67

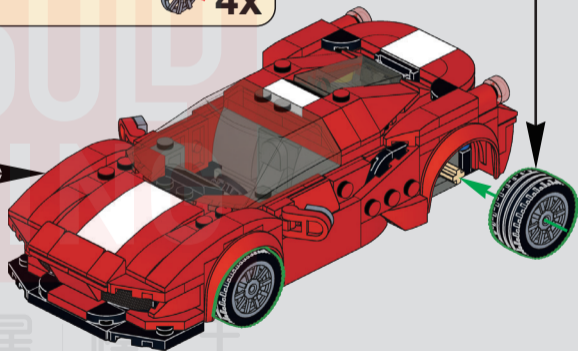
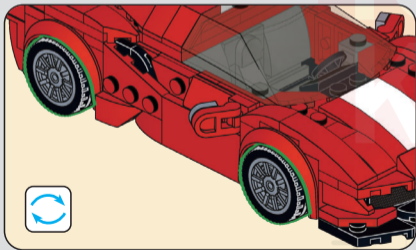

68

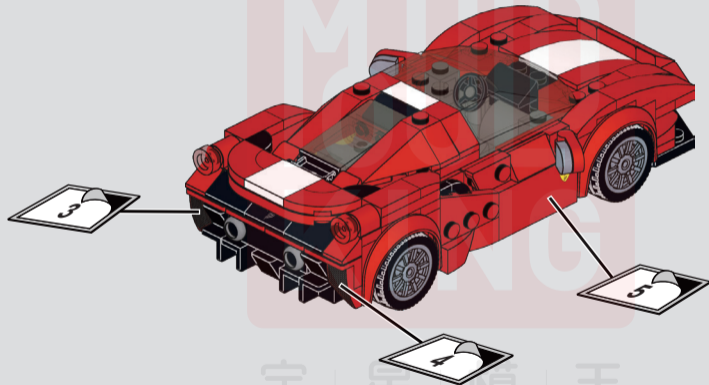

69

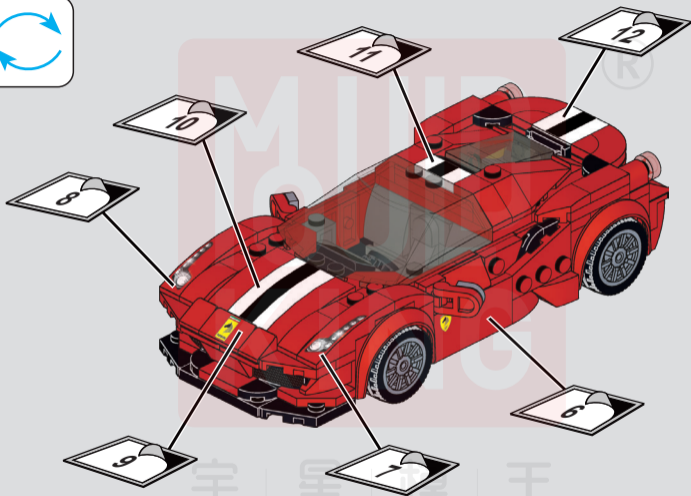

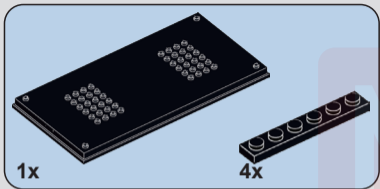

70

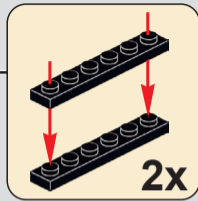
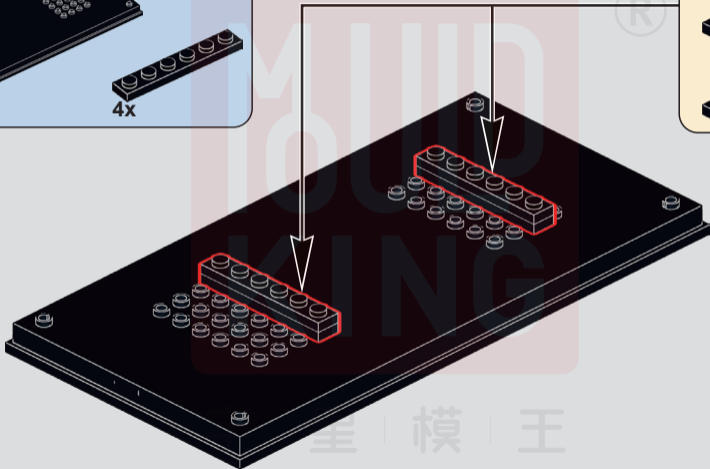

71

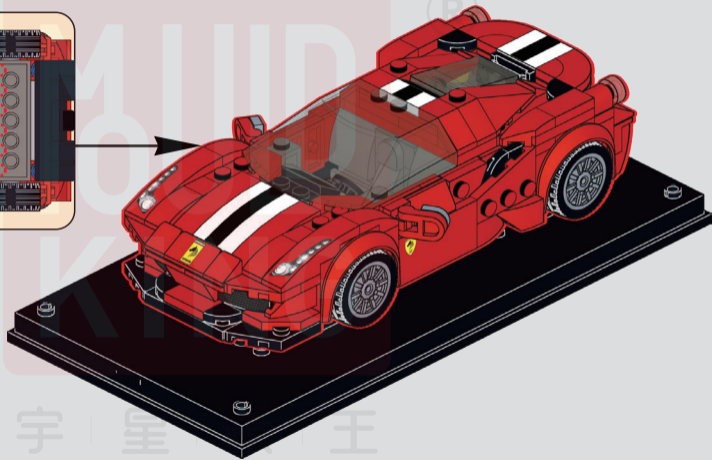
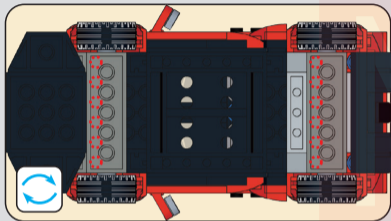

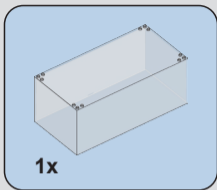

72

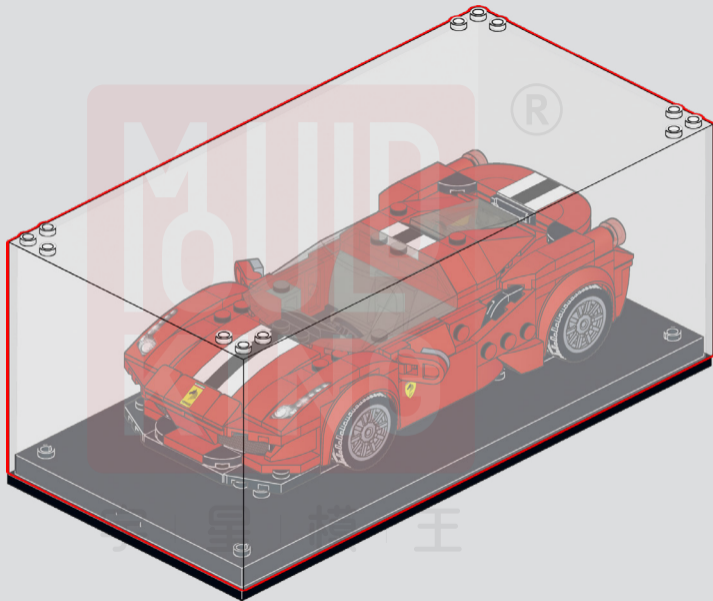

73

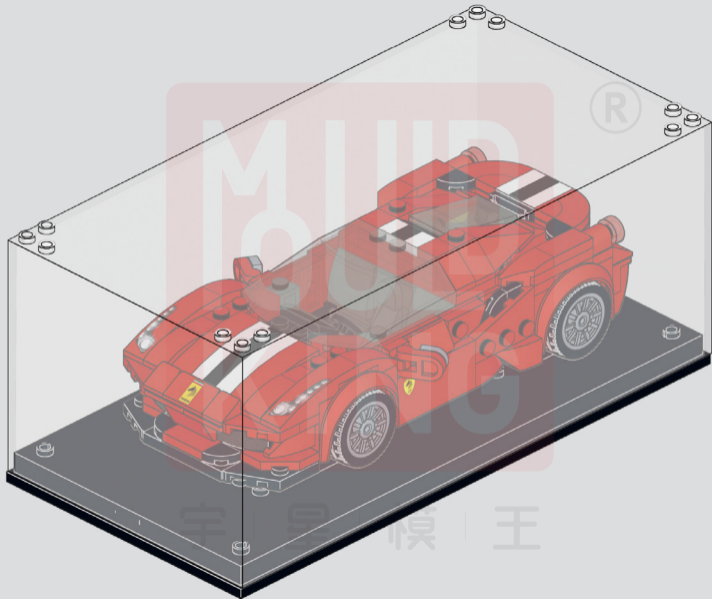

**MOULD
KING**

®

Model S
宇星车模

"迷你"名车

NO.488 GTB

宇 | 星 | 模 | 王

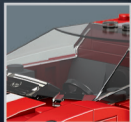
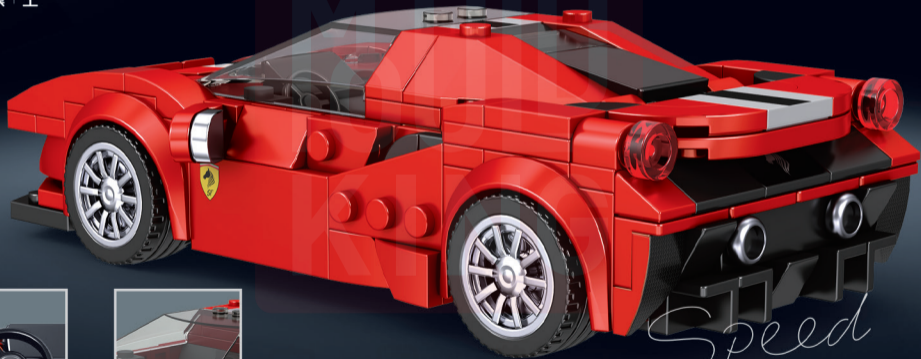

Speed